

Technical data sheet

Product features



Cutter 5l

Model

SAP Code

00013737



- Material: Stainless steel
- Device capacity [l]: 5.00
- Control type: Mechanical 24 V: Start, stop, puls
- Safety cover: polycarbonate with squeegee
- Number of revolutions / min: 1400
- Start /stop: Yes
- Safety element: lid microswitch
- Standard equipment for device: smooth knife included in the price of the machine
- Additional information: possibility to order perforated and serrated knife

SAP Code	00013737	Power electric [kW]	1.140
Net Width [mm]	260	Loading	230 V / 1N - 50 Hz
Net Depth [mm]	290	Number of revolutions / min	1400
Net Height [mm]	500	Device capacity [l]	5.00
Net Weight [kg]	23.50		

Technical data sheet

Technical drawing



Cutter 5l

Model

SAP Code

00013737

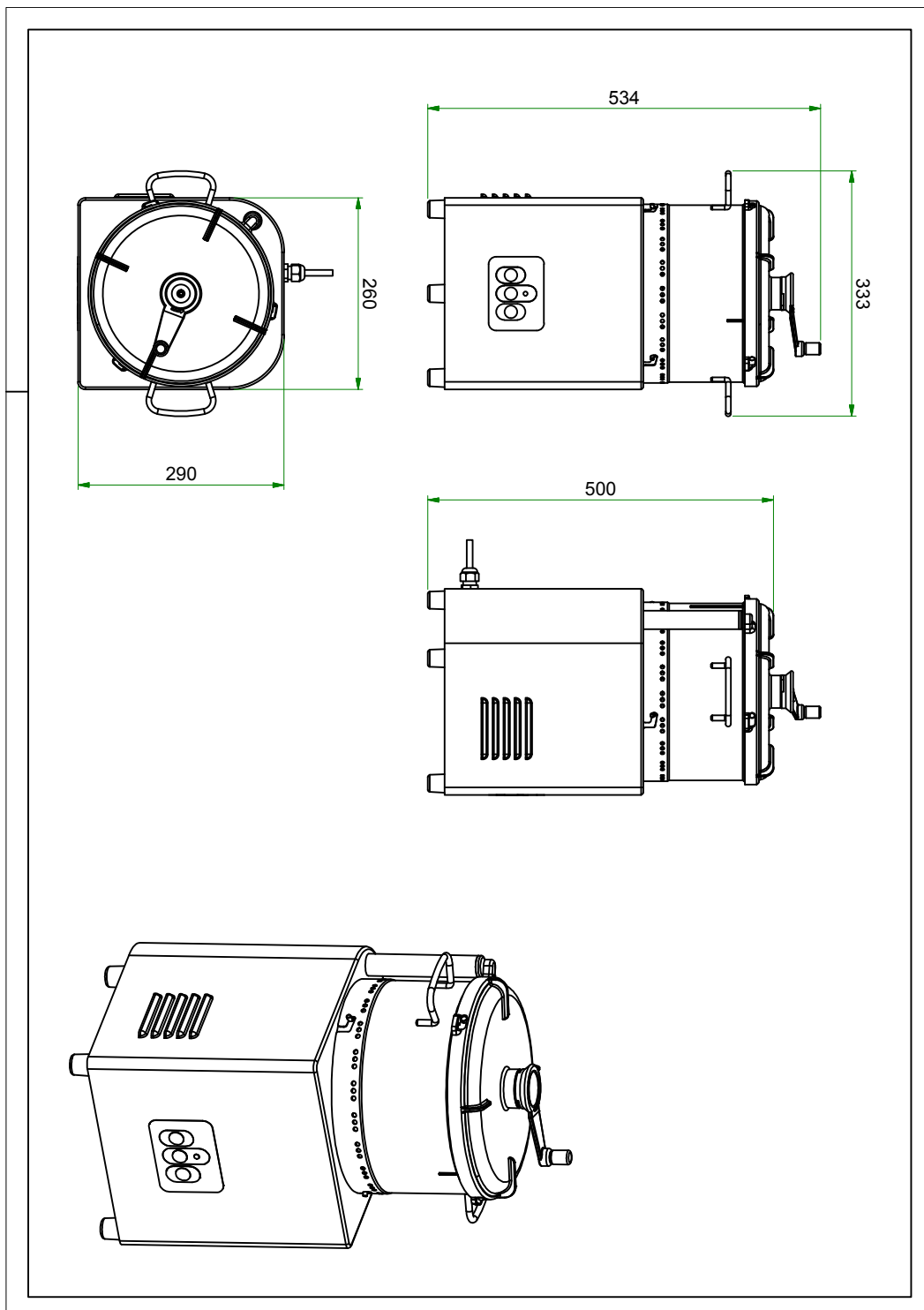

Technical data sheet

Product benefits



Cutter 5l

Model

SAP Code

00013737

1

All-stainless design

- robustness
purity
- long service life
 - very easy to clean

2

Polycarbonate lid

- transparent
- thanks to the transparent lid, I can easily follow the processing process, I don't waste time opening and peeking

3

Safety microswitches

- safe operations
- the machine cannot be started without perfect closure, thus protecting the health of the workers

4

Three knives to choose from

- variability of use for chopping, whipping and kneading
- variability of use saves the cost of purchasing additional machines

5

A trowel

- there will be 100% whipping/whipping/cutting...
- no waste, easy to wipe off quickly, no lumps in the final product

6

Pulsed and sustained running

- the operator has the option of choosing the coarseness of chopping/beating rate
- variability in food processing allows the highest quality of food to be achieved e.g. chopped onions do not turn bitter when pulse chopped

Technical data sheet

Technical parameters



Cutter 5l

Model

SAP Code

00013737

1. SAP Code:

00013737

2. Net Width [mm]:

260

3. Net Depth [mm]:

290

4. Net Height [mm]:

500

5. Net Weight [kg]:

23.50

6. Gross Width [mm]:

340

7. Gross depth [mm]:

385

8. Gross Height [mm]:

755

9. Gross Weight [kg]:

25.50

10. Device type:

Electric unit

11. Material:

Stainless steel

12. Power electric [kW]:

1.140

13. Loading:

230 V / 1N - 50 Hz

14. Device capacity [l]:

5.00

15. Control type:

Mechanical 24 V: Start, stop, puls

16. Safety cover:

polycarbonate with squeegee

17. Safety element:

lid microswitch

18. Number of revolutions / min:

1400

19. Safety Microswitch:

Yes

20. Start /stop:

Yes

21. Standard equipment for device:

smooth knife included in the price of the machine

22. Additional information:

possibility to order perforated and serrated knife

23. Unmountable bowl:

Yes

24. Suitable operations:

Chopping, whipping and kneading